

26

DREAM

BEDROOM FURNITURE





DREAM

BEDROOM FURNITURE

Furnish holistically, feel good all round.

A home is well balanced when all rooms work together harmoniously. What started with kitchen, bathroom and living is now continuing: The bedroom is now also becoming part of the well thought out living concept. This creates a living experience that impresses from one room to the next – with individual planning, perfect coordination and consistency in every detail.

In addition to a large selection of wardrobes, you also have a range of chests of drawers, bedside tables and matching accessories to choose from – for a bedroom with perfect furnishings all round.

04 | Bedroom furniture
Basic system

06 | Wardrobes
Customised design

10 | Chests of drawers and bedside tables
Customised design

12 | Design suggestions
Wardrobes

19 | Wardrobe
carcase elements and doors

22 | Wardrobe
hinged doors

26 | Wardrobe
sliding doors

34 | Occasional furniture
and accessories

BEDROOM FURNITURE

BASIC SYSTEM

Your step-by-step instructions for the perfect bedroom. The new Dream range impresses with a clear and well-arranged basic structure – wardrobes, occasional furniture and accessories can be easily and individually arranged to create a harmonious overall concept.

1 CARCASE SELECTION

Basic and extension elements in two heights and four widths are available as basis for your wardrobe. The basic elements can be extended with any number of extension elements. You can use this to design your wardrobe in continuous style.

1a Select the height

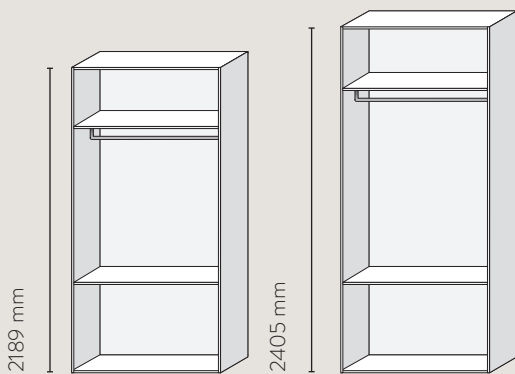

1b Select the width of the basic element

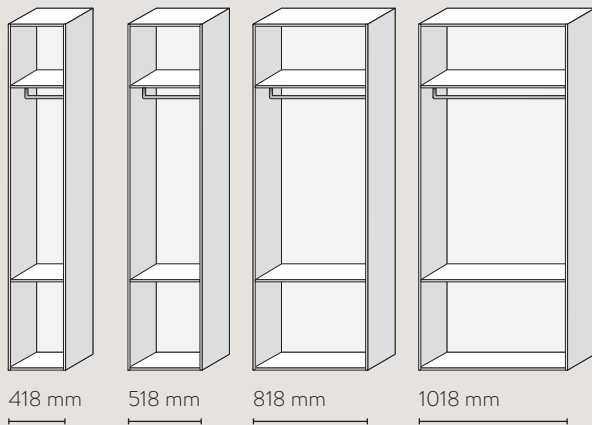

1c Select the extension elements in the desired width

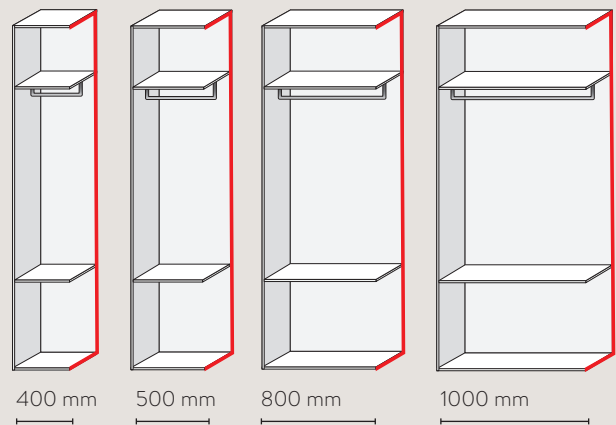

Combinatorics of the basic and extension elements

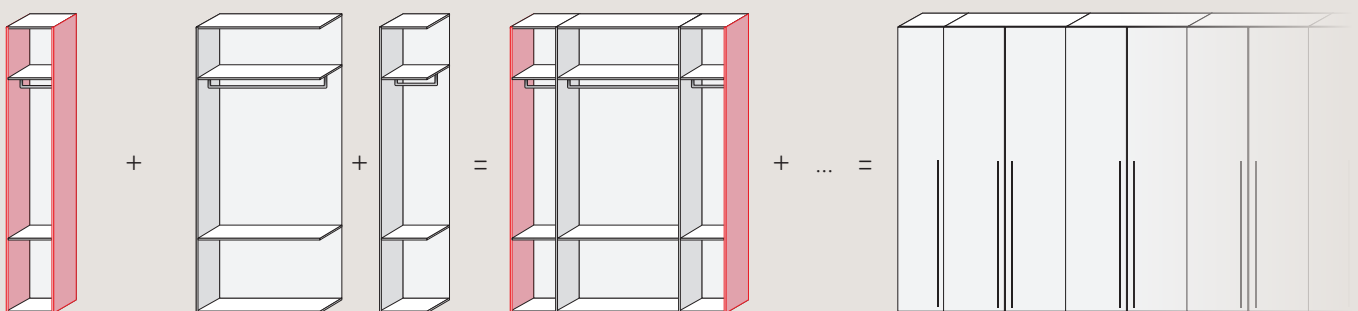

Continuous planning →

2 SELECTION OF INTERIOR FITTINGS

Each carcass element has two shelves and one wardrobe rail as standard. Optionally, further shelves, wardrobe rails, two internal drawers or shelf inserts can be added.

Standard fittings

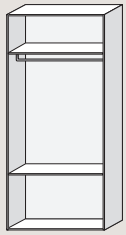

Optional fittings

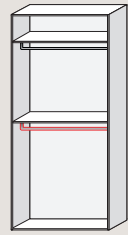

Wardrobe rail

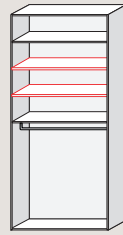

Set of 2 shelves

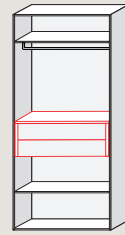

Set of 2 internal drawers *

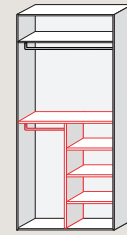

Shelf insert with wardrobe rail and 3 shelves

*The set always consists of two internal drawers with push-to-open technology for opening. The set can be positioned on the plinth base or wall-mounted (as shown). In addition, multiple sets can be stacked on top of one another.

3 SELECTION OF DOORS

The carcass combinations can be designed open, with hinged or sliding doors. Four handle versions in three lengths or a handleless push-to-open solution are available for the hinged doors. Sliding doors are available either with a passe-partout frame directly on the carcass or planned as room element from wall to wall. Optionally, the sliding doors can be visually separated in the middle with panel-dividing rail (further ordering information from p. 12).

3a Hinged doors

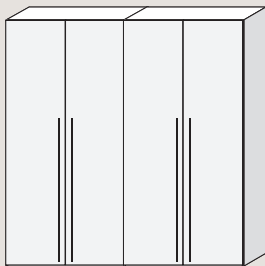

3b Sliding doors on the carcass with passe-partout frame

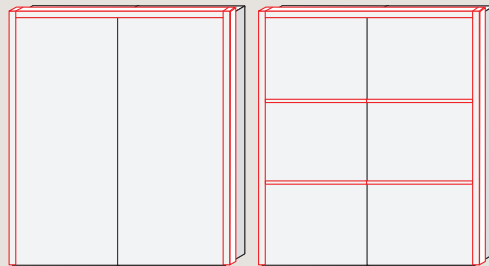

optionally with paneldividing rail

3c Sliding doors as room element, flush-to-wall-mounted

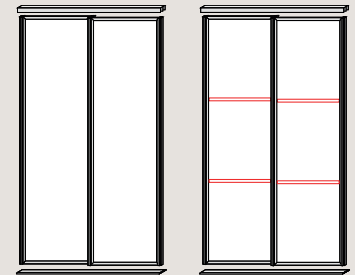

optionally with paneldividing rail

4 ADDITION OF OCCASIONAL FURNITURE AND ACCESSORIES

Matching chests of drawers, bedside tables and accessories are available for our wardrobes for a coordinated bedroom design. The chests of drawers come in two heights and five widths. The bedside tables are available in four heights and two widths. Mirrors and plug-in wall shelves add an individual touch.

Chests of drawers

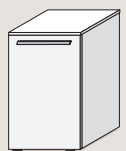

Hinged door



Drawers and pull-outs

Bedside tables



Floor-standing

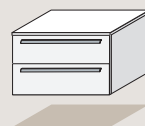

Wall-mounted

Mirrors

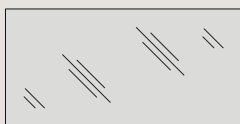

Portrait and landscape orientation

ABRIL



GRAYCE

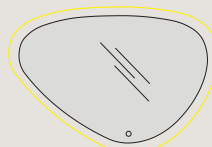

Plug-in wall shelf



In dimensions: 400, 600, 800, 1000 and 1200 mm

WARDROBES

CUSTOMISED DESIGN

Above all, a wardrobe should have the following: sufficient storage space. Individual interior partitions are crucial here, whether in the form of wardrobe rails, shelves or drawers. The door design also plays a part: classic hinged doors or space-saving sliding doors. What is important is that the wardrobe makes the most of the available space. The basis is a flexible carcass system in continuous style, enabling individual fitting options and optimum use of space. Wardrobes can be planned individually and in just a few simple steps with their current design options.



1 CARCASE DÉCORS

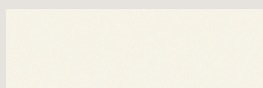

106 White

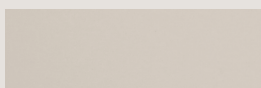

122 Sand



362 Como oak reproduction

Carcase interior décor

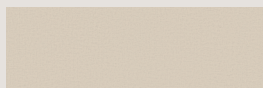

076 Textile Sand

(wardrobes inside have the Textile Sand carcasse interior décor as standard)

2 HINGED DOORS

2a FRONT DÉCORS

Price group 2
Program 064



640 Como oak reproduction

Price group 3
Program 063



621 Lacquer, honed white



623 Lacquer, honed sand matt



622 Lacquer, honed slate grey matt

Price group 7
Program 065

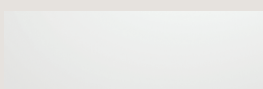

624 Mirror *

(Textile Sand on support plate, circular aluminium-coloured edge)

2b HANDLES **

The handles for hinged doors are available in three different sizes M, L and XL.
DS = Drill spacing

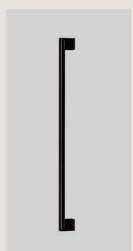

400 Railing handle
Black

GR-M
Length 401 mm / DS 391

GR-L
Length 1121 mm / DS 2 x 555.5

GR-XL
Length 1481 mm / DS 2 x 735.5



620 Railing handle
Black

GR-M
Length 411 mm / BA 391

GR-L
Length 1131 mm / BA 2 x 555.5

GR-XL
Length 1491 mm / BA 2 x 735.5

Points
Railing handles

GR-M
+ 31

GR-L
+ 44

GR-XL
+ 69



890 Railing handle
Stainless steel appearance

GR-M
Length 401 mm / DS 391

GR-L
Length 1121 mm / DS 2 x 555.5

GR-XL
Length 1481 mm / DS 2 x 735.5



650 Railing handle
Stainless steel appearance

GR-M
Length 411 mm / DS 391

GR-L
Length 1131 mm / DS 2 x 555.5

GR-XL
Length 1491 mm / DS 2 x 735.5



PTO Push-to-open
for doors

Item number
99017

Abbreviation
PTO1B

Points
54

* For the mirrored doors, one offset handle as well as adapter for mounting the railing handle on the door are automatically included in the delivery.
** One handle or one PTO must be ordered and invoiced per hinged door. Please specify the handle number and respective length.

3 SLIDING DOORS



3a FRONT DÉCORS

Price group 2					
	892 Concrete grey reproduction*	889 Concrete Slate Grey reproduction*			
Price group 3					
	488 Lacquer, premium honed white	491 Lacquer, premium honed slate grey	336 Lacquered laminate, ivory supermatt	338 Lacquered laminate, satin grey supermatt	341 Lacquered laminate, stone grey supermatt
	405 Sierra oak reproduction*	402 Havana oak reproduction*			
Price group 4					
	967 Lacquered laminate, Alpine white ultra matt	969 Lacquered laminate, Sand ultra matt	970 Lacquered laminate, taupe grey ultra matt	961 Lacquered laminate, graphite black ultra matt	
	101 Mirror (with safety film, white rear face)				
Price group 7					
	103 Mirror, bronze colour (with safety film, white rear face)	104 Grey glass (toughened safety glass, TSG)			

3b TRACK PROFILE COLOURS

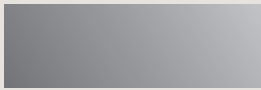

014 Stainless steel appearance

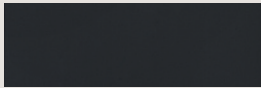

010 Black



Track profile

The track set consists of top and bottom track. The top track (height: 40 mm) is screwed and can be optionally mounted inside the passe-partout frame or directly at the top. The bottom track has a height of 6 mm and is bonded. Not suitable for velours and shag carpeting.

3c PASSE-PARTOUT FRAME

25 mm thickness

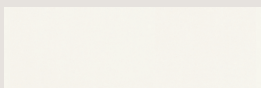

193 Alpine white

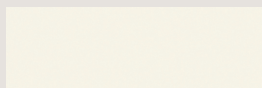

106 White

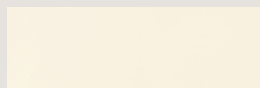

120 Ivory matt

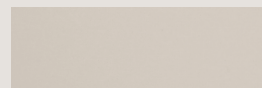

122 Sand

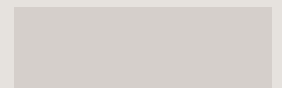

070 Satin grey



089 Stone grey

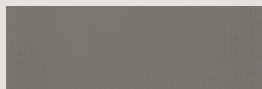

071 Taupe grey



194 Slate grey



127 Black



362 Como oak reproduction



198 Sierra oak reproduction

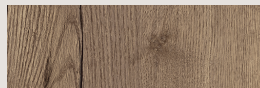

097 Havana oak reproduction

ORDER OPTION VISUALLY DIVIDED FRONTS

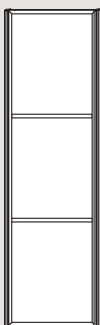

At a surcharge, **GTS120** sliding doors are available with panel-dividing rails.

Item number

GTS120 (1406)

Points

415



The centre panel can be delivered in a different décor at a surcharge **MP-GTDW**.

Item number

MP-GTDW (1407)

Points

127

OCCASIONAL FURNITURE

CHESTS OF DRAWERS, BEDSIDE TABLES AND PLUG-IN WALL SHELVES

For a complete bedroom design, our occasional furniture rounds off the overall picture harmoniously. Our chests of drawers, bedside tables and plug-in wall shelves create additional storage space and turn your bedroom into a well balanced unit. The large selection of décors enables individual coordination with the respective wardrobe configuration. Eleven carcass décors, two carcass interior décors, 15 front décors and twelve top shelves are available. The selection of four handle versions round off the visual appearance and place subtle accents. Please indicate the desired options when placing your order.



1 CARCASS DÉCORS

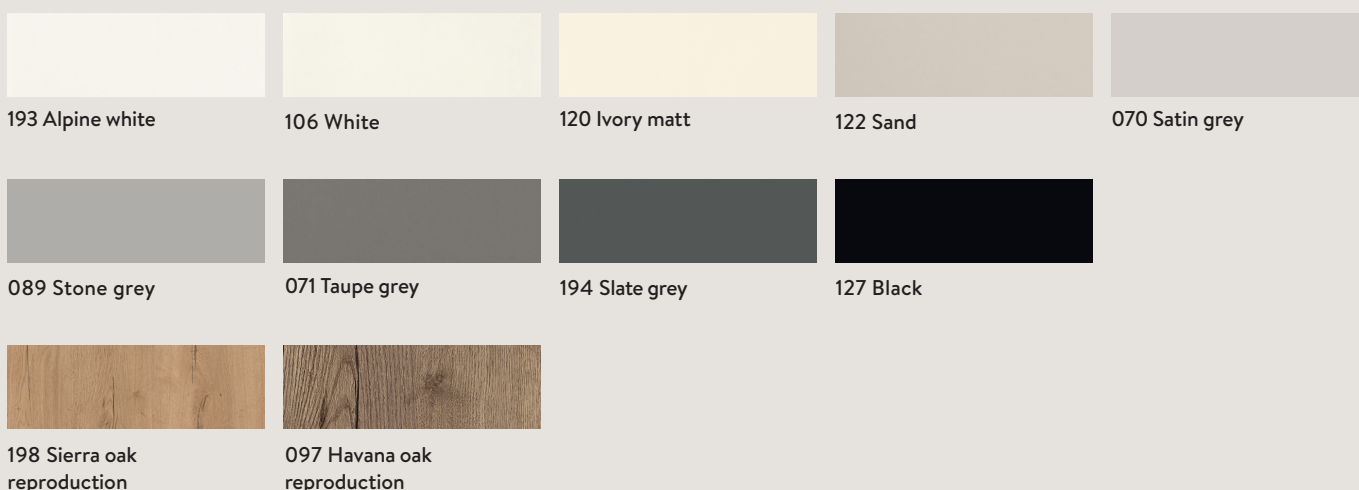

Carcass interior décor

White
(Bedside tables and chests of drawers are white in the carcass interior décor)

Slate grey
(The interior décor is available exclusively for carcass décor 194 Slate grey in combination with the surcharge MP-KID 7947 for + 96 points)

2 FRONTS

Price group 2



892 Concrete grey reproduction



889 Concrete Slate Grey reproduction

Price group 3

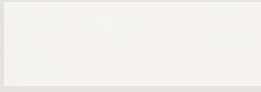

490 Lacquer, premium honed alpine white

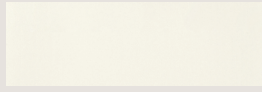

488 Lacquer, premium honed white



491 Lacquer, premium honed slate grey

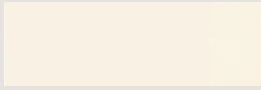

336 Lacquered laminate, ivory supermatt

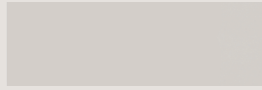

338 Lacquered laminate, satin grey supermatt

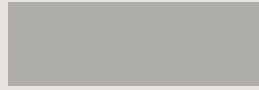

341 Lacquered laminate, stone grey supermatt



406 Como oak reproduction

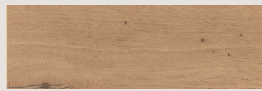

405 Sierra oak reproduction

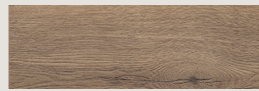

402 Havana oak reproduction

Price group 4

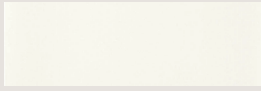

967 Lacquered laminate, Alpine white ultra matt

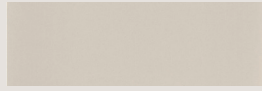

969 Lacquered laminate, Sand ultra matt

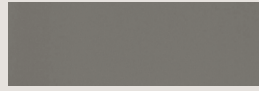

970 Lacquered laminate, taupe grey ultra matt

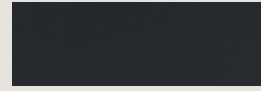

961 Lacquered laminate, graphite black ultra matt

3 TOP SHELVES AND PLUG-IN WALL SHELVES

Top shelves and plug-in wall shelves: 16 mm thickness

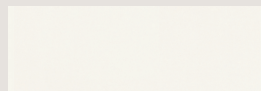

193 Alpine white

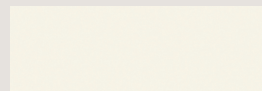

106 White

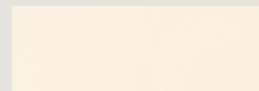

120 Ivory matt

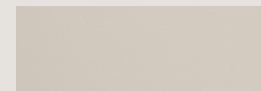

122 Sand

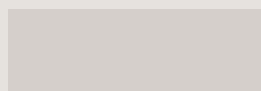

070 Satin grey



089 Stone grey



071 Taupe grey

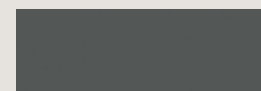

194 Slate grey



127 Black

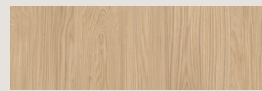

362 Como oak reproduction

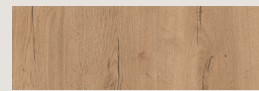

198 Sierra oak reproduction



097 Havana oak reproduction

4 HANDLES*

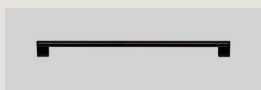

400 Railing handle Black

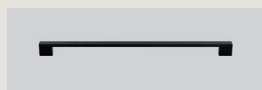

620 Railing handle Black

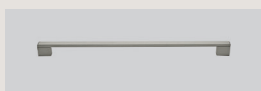

650 Railing handle Stainless steel appearance

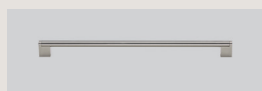

890 Railing handle Stainless steel appearance



PTO1B (99017)
Push-to-open for hinged doors, 54 points



MP-PTOSA (7692)
Push-to-open for drawers and pull-outs, 158 points

* Chests of drawers and bedside tables are equipped automatically with railing handles. The railing handles are positioned horizontally and are included in the price of the furniture. Please indicate the handle number in your order. The occasional furniture can optionally also be ordered with PTO (surcharge PTO1B/PTOSA).

DESIGN SUGGESTIONS

WARDROBES

The following pages will present you with well thought out design suggestions, enabling simple and at the same time inspiring wardrobe design. They show how our wardrobes can be combined harmoniously and functionally. Solutions that can be directly adopted and realised. These suggestions can also be experienced live in our current exhibition.



COMBINATION 01 | W 2018 mm | H 2405 mm | D 613 mm

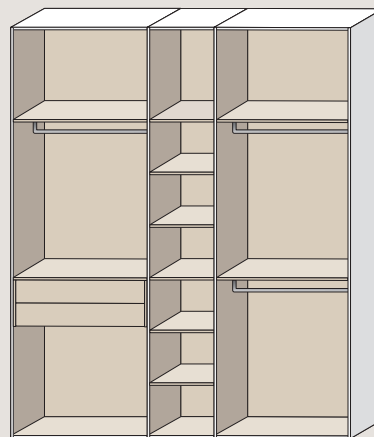
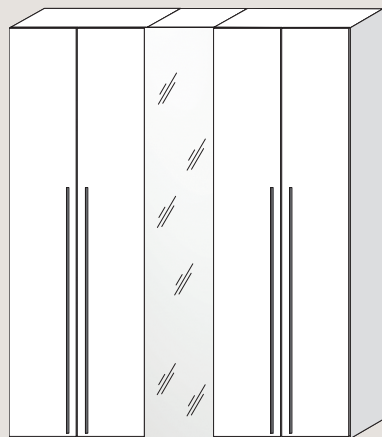

Décors: Front 1: 621 Lacquer, honed white (PG 3) | Front 2: 624 Mirror (PG 7) |
Carcase: 106 White | Handle: 890 Railing handle Stainless steel appearance, GR-XL

Set description	Order no.	Abbreviation	Width in mm	Price groups / Points
Wardrobe, consisting of				
1 basic element, 818 mm wide, 2405 mm high	49707	KSG80-240	818	1,478
1 extension element 400 mm wide, 2405 mm high	49720	KSA40-240	400	965
1 extension element 800 mm wide, 2405 mm high	49722	KSA80-240	800	1,251
1 drawer insert with 2 internal drawers	48742	SKE-KS80	781	596
2 shelf sets, consisting of 2 shelves, 25 mm thick	29110	EB-KS40	381	251
1 wardrobe rail	28687	ST-KS80	770	91
4 handles, length XL	99022	GR-XL	-	274
1 door opening system push-to-open PTO	99017	PTO1B	-	54
5 Hinged doors usable with hinges right / left 4 hinged doors, front 621 Lacquer, honed white, PG 3 1 hinged door, front 624 Mirror, PG 7	49728	KST40-240	-	1,974 702
Total sum				7,636

COMBINATION 02 | W 2418 mm | H 2405 mm | D 613 mm

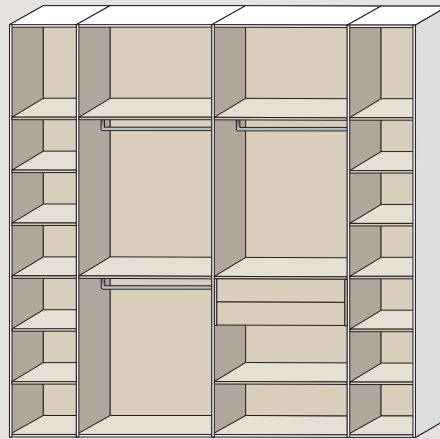
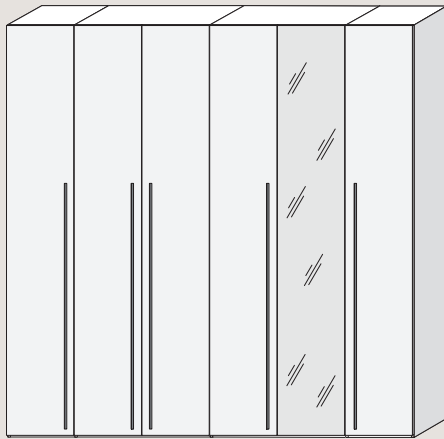

Décors: Front 1: 622 Lacquer, honed slate grey matt (PG 3) | Front 2: 624 Mirror (PG 7) |
Carcase: 122 Sand | Handle: 400 Railing handle black, GR-XL

Set description	Order no.	Abbreviation	Width in mm	Price groups / Points
Wardrobe, consisting of				
1 basic element, 418 mm wide, 2405 mm high	49705	KSG40-240	418	1,193
2 extension elements 800 mm wide, 2405 mm high	49722	KSA80-240	800	2,502
1 extension element 400 mm wide, 2405 mm high	49720	KSA40-240	400	965
4 shelf sets, consisting of 2 shelves, 25 mm thick	29110	EB-KS40	381	502
1 drawer insert with 2 internal drawers	48742	SKE-KS80	781	596
1 wardrobe rail	28687	ST-KS80	770	91
5 handles, length XL	99022	GR-XL	-	343
6 Hinged doors usable with hinges right / left	49728	KST40-240	-	2,467
5 hinged doors, front 622 Lacquer, honed slate grey matt, PG 3				702
1 hinged door, front 624 Mirror, PG 7				
Total sum				9,361

COMBINATION 03 | W 3018 mm | H 2189 mm | D 613 mm

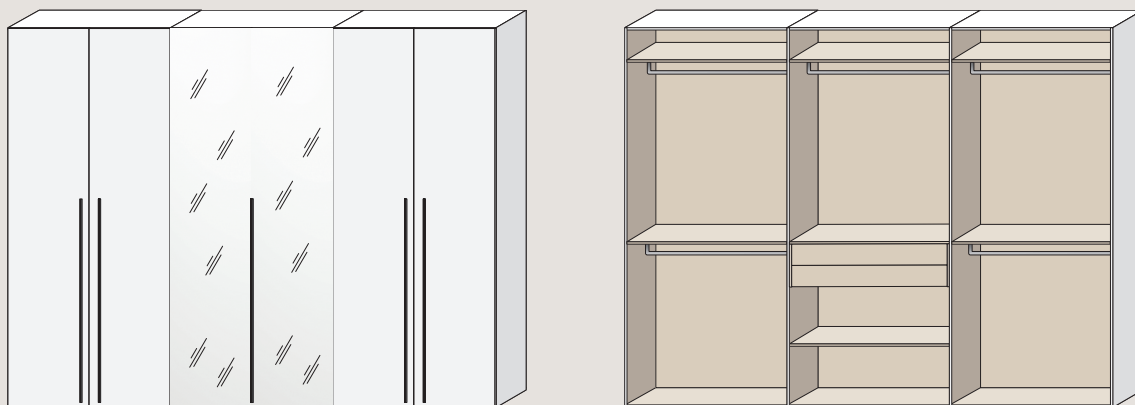

Décors: Front 1: 640 Como oak reproduction (PG 2) | Front 2: 624 Mirror (PG 7) |
 Carcase: 362 Como oak reproduction | Handle: 620 Railing handle black, GR-XL

Set description	Order no.	Abbreviation	Width in mm	Price groups / Points
Wardrobe, consisting of				
1 basic element, 1018 mm wide, 2189 mm high	48708	KSG100-220	1,018	1,551
2 extension element 1000 mm wide, 2189 mm high	48723	KSA100-220	1,000	2,689
2 wardrobe rail	28688	ST-KS100	970	190
1 drawer insert with 2 internal drawers	48743	SKE-KS100	981	667
5 handles, length XL	99021	GR-L	–	219
6 hinged doors usable with hinges right / left	48729	KST50-220	–	1,892
4 hinged doors, front 640 Como oak reproduction, PG 2			–	1,513
2 hinged doors, front 624 Mirror, PG 7				
Total sum				8,721

COMBINATION 04 | W 2818 mm | H 2405 mm | D 620 mm

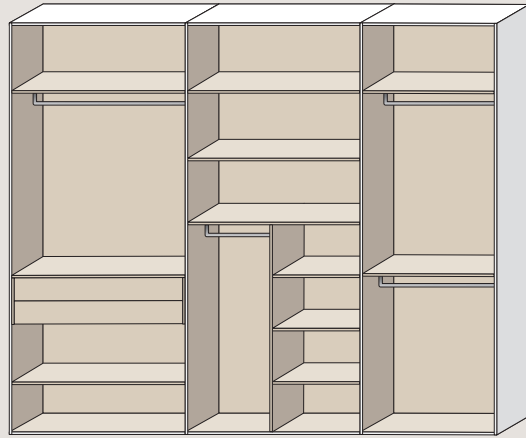
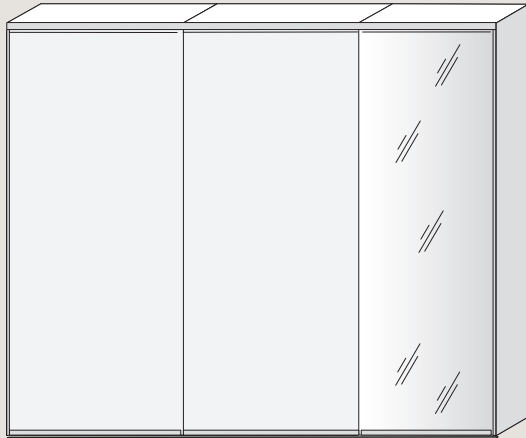

Décors: Front 1: 338 Lacquered laminate, satin grey supermatt (PG 3) | Front 2: 101 Mirror (PG 4) |
 Carcase: 122 Sand | Track profile: 010 Black

Set description	Order no.	Abbreviation	Width in mm	Price groups / Points
Wardrobe, consisting of				
1 basic element, 1018 mm wide, 2405 mm high	49708	KSG100-240	1,018	1,618
1 extension element 1000 mm wide, 2405 mm high	49723	KSA100-240	1,000	1,390
1 extension element 800 mm wide, 2405 mm high	49722	KSA80-240	800	1,251
1 drawer insert with 2 internal drawers	48743	SKE-KS100	981	667
1 shelf insert, consisting of 1 wardrobe rail, 3 insertable shelves	48748	RET-KS100	981	518
1 wardrobe rail	28687	ST-KS80	770	91
Sliding doors	1443	GSSET-003		-
3 x base price sliding door	1404	GGT	-	3,951
3 sliding doors 2 sliding doors, front 338 Lacquered laminate, satin grey supermatt, PG 3 1 sliding door, front 101 Mirror, PG 4	1401	GT120	-	1,363 622
1 track set double-track for sliding doors	1432	GSSET-2L	-	381
Total sum				11,852

COMBINATION 05 | W 2518 mm | H 2189 mm | D 620 mm

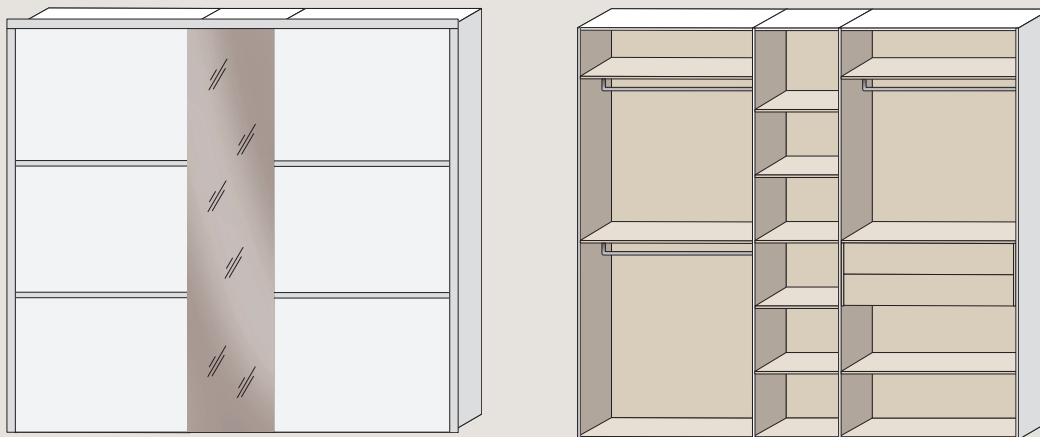

Décor: Front 1: 405 Sierra oak reproduction (PG 3) | Front 2: 103 Mirror, bronze colour (PG 7) |
 Carcase: 122 Sand | Passe-partout frame: 198 Sierra oak reproduction | Track profile: 010 Black

Set description	Order no.	Abbreviation	Width in mm	Price groups / Points
Wardrobe, consisting of				
1 basic element, 1018 mm wide, 2189 mm high	48708	KSG100-220	1,018	1,551
1 extension element 500 mm wide, 2189 mm high	48721	KSA50-220	500	999
1 extension element 1000 mm wide, 2189 mm high	48723	KSA100-220	1,000	1,345
1 wardrobe rail	28688	ST-KS100	970	95
2 shelf sets, consisting of 2 shelves, 25 mm thick	29111	EB-KS50	481	283
1 drawer insert with 2 internal drawers	48743	SKE-KS100	981	667
1 passe-partout frame, 25 mm thick	25005	PR25-220	2,568	729
Sliding doors	1446	GSSET-006		-
3 x base price sliding door	1404	GGT	-	3,951
3 sliding doors 2 sliding doors, front 405 Sierra oak reproduction, PG 3 1 sliding door, front 103 Mirror, bronze colour, PG 7	1401	GT120	-	1,220 449
1 track set triple-track for sliding doors	1433	GSSET-3L	-	524
2 x surcharge for sliding door with panel-dividing rail	1406	GTS120	-	829
Total sum				12,642

COMBINATION 06 | W 3618 mm | H 2405 mm | D 620 mm

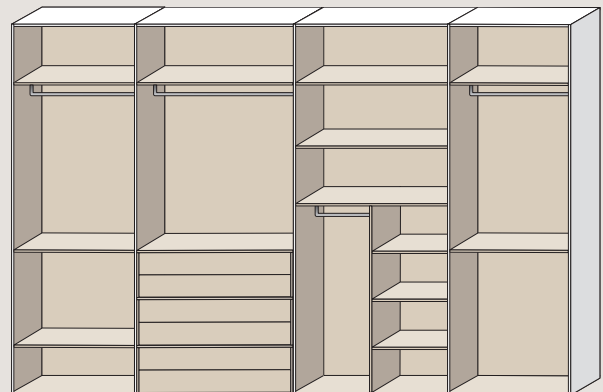
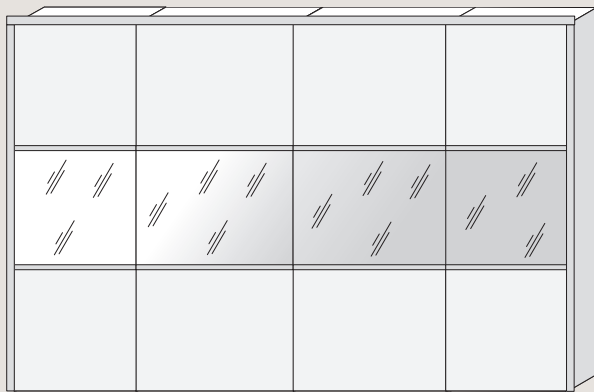

Décors: Front 1: 969 Lacquered laminate, Sand ultra matt (PG 4) | Front 2: 101 Mirror (PG 4) |
 Carcase: 122 Sand | Passe-partout frame: 122 Sand | Track profile: 014 Stainless steel appearance

Set description	Order no.	Abbreviation	Width in mm	Price groups / Points
Wardrobe, consisting of				
1 basic element, 818 mm wide, 2405 mm high	49707	KSG80-240	818	1,478
2 extension elements 1000 mm wide, 2405 mm high	49723	KSA100-240	1000	2,780
1 extension element 800 mm wide, 2405 mm high	49722	KSA80-240	800	1,251
3 drawer inserts with 2 internal drawers	48743	SKE-KS100	981	2,002
1 shelf insert, consisting of 1 wardrobe rail, 3 insertable shelves	48748	RET-KS100	981	518
1 shelf sets, consisting of 2 shelves, 25 mm thick	29112	EB-KS80	781	196
1 passe-partout frame, 25 mm thick	25015	PR25-240	3,668	734
Sliding doors	1444	GSSET-009		–
4 x base price sliding door	1404	GGT	–	5,268
4 sliding doors 4 sliding doors, front 969 Lacquered laminate, Sand ultra matt, PG 4	1401	GT120	–	2,590
1 track set triple-track for sliding doors	1432	GSSET-3L	–	745
4 x surcharge for sliding door with panel-dividing rail	1406	GTS120	–	1,659
4 x surcharge for different décor on sliding doors with panel-dividing rails	1407	MP-GTDW	–	508
Total sum				19,729

WARDROBES

CARCASE ELEMENTS AND DOORS

BASIC ELEMENTS | H 2189 mm | D 595 mm

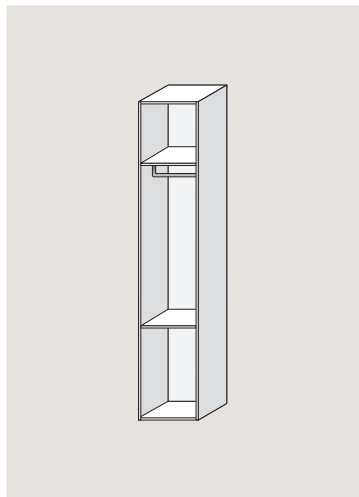

Item description	Order no.	Abbreviation	Width in mm	Points
Basic element, consisting of	48705	KSG40-220	418	1,137
2 outer faces	48706	KSG50-220	518	1,205
1 top shelf	48707	KSG80-220	818	1,415
1 plinth base	48708	KSG100-220	1,018	1,551
1 plinth panel				
2 shelves				
1 wardrobe rail				
Interior décor: Textile Sand				

BASIC ELEMENTS | H 2405 mm | D 595 mm

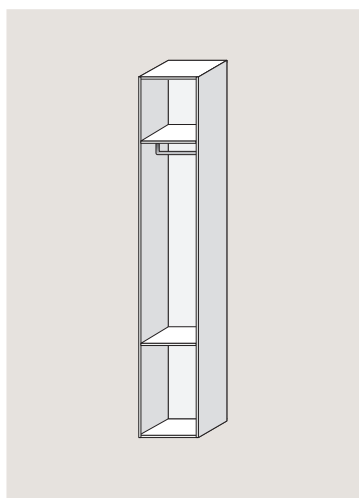

Item description	Order no.	Abbreviation	Width in mm	Points
Basic element, consisting of	49705	KSG40-240	418	1,193
2 outer faces	49706	KSG50-240	518	1,261
1 top shelf	49707	KSG80-240	818	1,478
1 plinth base	49708	KSG100-240	1,018	1,618
1 plinth panel				
2 shelves				
1 wardrobe rail				
Interior décor: Textile Sand				

EXTENSION ELEMENTS | H 2189 mm | D 595 mm

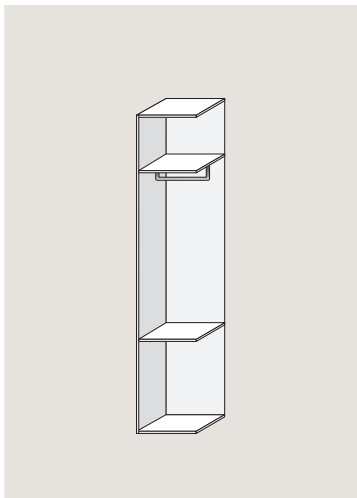

Item description	Order no.	Abbreviation	Width in mm	Points
Extension element, consisting of	48720	KSA40-220	400	931
1 center face	48721	KSA50-220	500	999
1 top shelf	48722	KSA80-220	800	1,207
1 plinth base	48723	KSA100-220	1,000	1,345
1 plinth panel				
2 shelves				
1 wardrobe rail				
Décor: Textile Sand				

EXTENSION ELEMENTS | H 2405 mm | D 595 mm

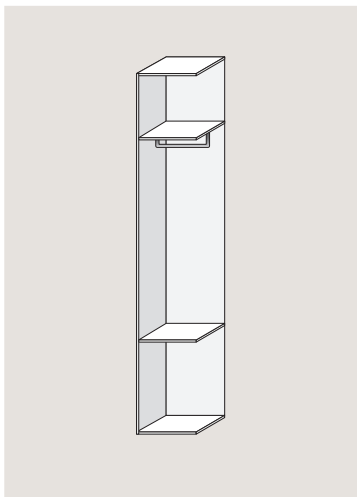

Item description	Order no.	Abbreviation	Width in mm	Points
Extension element, consisting of	49720	KSA40-240	400	965
1 center face	49721	KSA50-240	500	1,034
1 top shelf	49722	KSA80-240	800	1,251
1 plinth base	49723	KSA100-240	1,000	1,390
1 plinth panel				
2 shelves				
1 wardrobe rail				
Décor: Textile Sand				

OPTIONAL INTERIOR FITTINGS | FILLERS | CEILING END PANEL

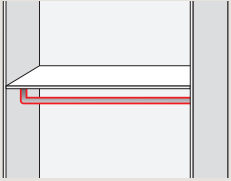
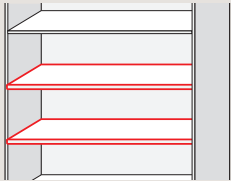
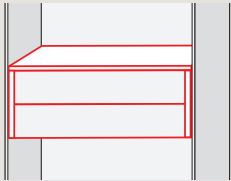
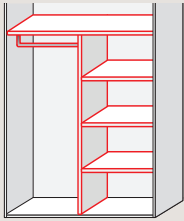
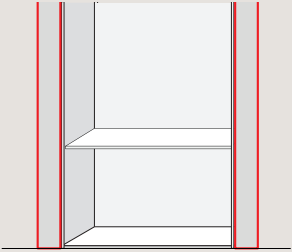
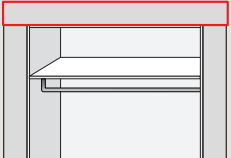
	Item description	Order no.	Abbreviation	Width in mm	Points
	Wardrobe rail square made of metal 28 mm deep, 10 mm wide	28685	ST-KS40	370	82
		28686	ST-KS50	470	85
	2 screws for fastening on the shelf are included in the scope of delivery	28687	ST-KS80	770	91
		28688	ST-KS100	970	95
	Shelf set for wardrobes, 2 shelves, 25 mm thick 549.5 mm deep	29110	EB-KS40	381	126
		29111	EB-KS50	481	142
		29112	EB-KS80	781	196
		29113	EB-KS100	981	228
	Drawer set for wardrobes 320 mm high, 483 mm deep, 2 internal drawers with mechanical opening support mechanism 2 side sections 1 shelf Installation possible as shown or mirrored. Stackable with each other.	48742	SKE-KS80	781	596
		48743	SKE-KS100	981	667
	Shelf unit insert for wardrobes 1280 mm high, 549 mm deep, 1 centre panel 3 insertable shelves 1 wardrobe rail Installation possible as shown or mirrored.	48747	RET-KS80	781	482
		48748	RET-KS100	981	518
	Filler Carcase material 16 mm thick, 2189 mm high, 250 mm wide Minimum installation width: 45 mm	51827	KPK25-220	250	117
	as above, however 2405 mm high, 250 mm wide Minimum installation width: 45 mm The wood grain runs vertical in wood décors. Supplied in fixed dimensions, adaptation only possible on site!	51828	KPK25-240	250	128
	Ceiling end panel Carcase material, 16 mm thick, 250 – 400 mm high Minimum installation height: 45 mm The wood grain runs vertical in wood décors. Plan ceiling panels from wall to wall. For ideal ventilation, a shadow gap to the ceiling is required.	466	KDB	200 – 2030	5,8 (Price per 100 mm)

WARDROBES

HINGED DOORS



HINGED DOORS

Our wardrobes can be equipped with hinged doors or sliding doors as required. Hinged doors are characterised by simple shapes and many handle options. You can choose from four handle versions in three lengths or opt for a handleless push-to-open solution.



You can choose between doors with a width of 400 mm or 500 mm.

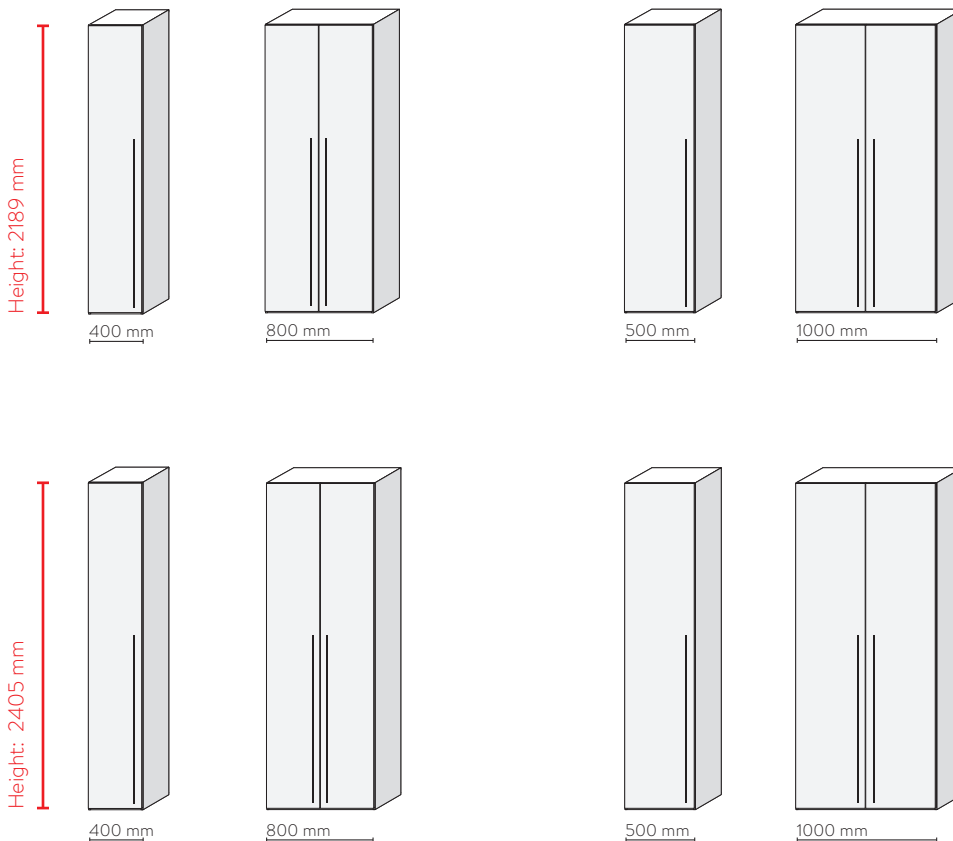

ORDERING INFORMATION HINGED DOORS

- From a carcass width of 800 mm and 1,000 mm, a design with two hinged doors is required.
- No handles are included in the scope of delivery. One handle or one PTO must be ordered and invoiced per hinged door. The desired version can be freely selected. Please specify the handle number and respective length. A template is supplied for mounting, which can be used for all handle sizes.
- For the mirrored doors, one offset handle as well as adapter for mounting the railing handle on the door are automatically included in the delivery for opening.
- If two mirrored doors are planned in front of a carcass, the adapters only allow 1 handle to be installed at the centre in the joint. The second door is opened by reaching behind the door.

HINGED DOORS | H 2157 mm | D 18 mm

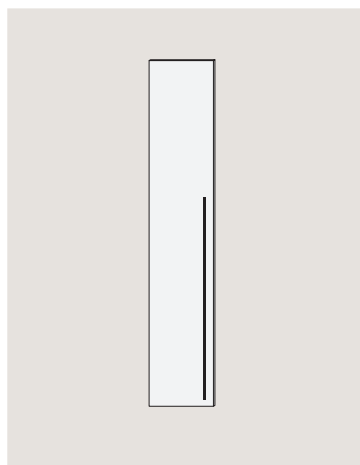



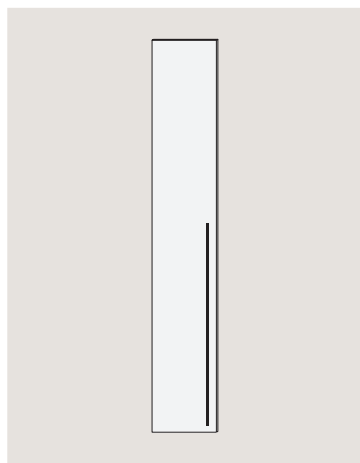

Item description	Order no.	Abbreviation	Width in mm	Price groups / Points		
				2	3	7
Hinged door for wardrobe incl. hinges, can be used on right / left	48728	KST40-220	394	434	476	656
	48729	KST50-220	494	473	523	756
One handle or one PTO must be ordered per hinged door.						

HINGED DOORS | H 2373 mm | D 18 mm



Item description	Order no.	Abbreviation	Width in mm	Price groups / Points		
				2	3	7
Hinged door for wardrobe incl. hinges, can be used on right / left	49728	KST40-240	394	445	493	702
	49729	KST50-240	494	491	549	799
One handle or one PTO must be ordered per hinged door.						

HANDLES *

	Item description	Order no.	Abbreviation	Length in mm	Drill spacing	Points
	Railing handle 400 1 railing handle round, black 36 mm high	99020	GR-M	401	391	31
		99021	GR-L	1.121	2 x 555,5	44
		99022	GR-XL	1.481	2 x 735,5	69
	Railing handle 890 1 railing handle round, stainless steel appearance 36 mm high	99020	GR-M	401	391	31
		99021	GR-L	1.121	2 x 555,5	44
		99022	GR-XL	1.481	2 x 735,5	69
	Railing handle 620 1 railing handle square, black 35 mm high	99020	GR-M	411	391	31
		99021	GR-L	1.131	2 x 555,5	44
		99022	GR-XL	1.491	2 x 735,5	69
	Railing handle 650 1 railing handle square, stainless steel appearance 35 mm high	99020	GR-M	411	391	31
		99021	GR-L	1.131	2 x 555,5	44
		99022	GR-XL	1.491	2 x 735,5	69
	Push-to-open for hinged doors	99017	PTO1B	–	–	54

WARDROBES

SLIDING DOORS



SLIDING DOORS

Another option are sliding doors, these can be planned on the carcass with a passe-partout frame or as room element from wall to wall and floor to ceiling. The top track is either screwed inside the passe-partout frame or in the ceiling. Sliding doors are space-saving, integrate seamlessly and are suitable for both built-in wardrobes as well as walk-in wardrobes. Door widths are between 500 and 1200 mm, heights between 700 and 2600 mm, for continuous doors depending on the décor, up to max. 2000 mm. Split doors are available at a surcharge with panel-dividing rail (GTS120, 1406) or a centre panel with a different décor (MP-GTDW, 1407). The minimum dimension per door is 500 × 700 mm.

THE TRACK PROFILE

- Track length: max. 5000 mm
- Colours: 014 Stainless steel appearance, 010 Black

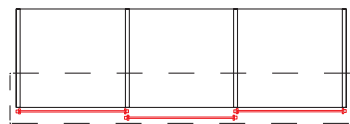

double-track (installation depth: 79 mm)

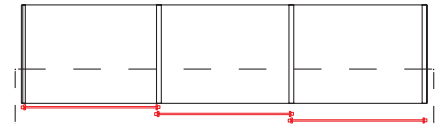

three-track (installation depth: 117 mm)

Scope of delivery per track set:

- Top and bottom tracks coated on both sides
- Top track position holder
- Sealing brush
- Bottom track topper in black or grey

* (The top track is 40 mm high and screwed, the bottom track is 6 mm high and self-adhesive.)

PLANNING AND CALCULATION INFORMATION

CALCULATION

- Door width = (total width + overlaps – brushes – wall connections) ÷ doors
- Door height = total height – 45 mm
- Total width = (doors × door width) – overlaps + brushes + wall connections

CALCULATION INFORMATION

- Take into account that cabinets and built-in units behind the sliding doors are easily accessible.
- The door arrangement must ensure problem-free accessibility of the entire interior system.
- Overlaps increase the door width by + 26 mm.
- Sealing brushes decrease the available opening width by – 3 mm.
- Wall connections decrease the available opening width by – 25 mm.

SLIDING DOOR BRAKES

- Doors > 750 mm: min. of 1 break recommended per door, 2 recommend as needed
- Doors < 750 mm: max. 1 break, tilt protection required
- The number of brakes per door must be specified with the order.
- Without specification of the closing direction: Mounting in accordance with catalogue specification.

DESIGN OF SLIDING DOORS

SLIDING DOORS ON THE CARCASE WITH PASSE-PARTOUT FRAME

Deep passe-partout frames 250 mm, width 25 mm

The passe-partout frame is used on the side as an end piece and stop and at the top for attaching the sliding door track if the room situation requires this.

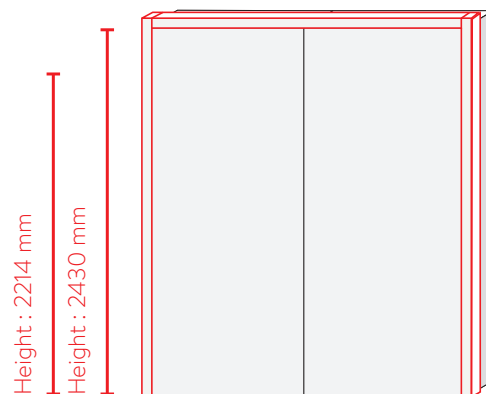

SLIDING DOORS AS ROOM ELEMENT, FLUSH-TO-WALL-MOUNTED

Deep top track 40 mm

If the cabinet is to run flush from one wall to the opposite wall, sliding door sets are a suitable option. The wardrobe is thus harmoniously integrated into the room architecture and becomes an inherent part of the room.

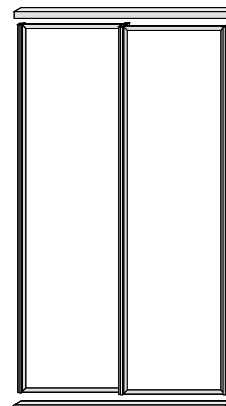

OPTIONAL PANEL-DIVIDING RAIL

- A surcharge per door is invoiced for sliding doors with a panel-dividing rail. In this case, the doors are visually divided into thirds in a symmetrical manner.
- If continuous and divided doors are combined in a set, please indicate which door is to be divided when placing your order.
- At a surcharge the centre panel can be delivered in a different décor.
- Please specify the different décor for each door.

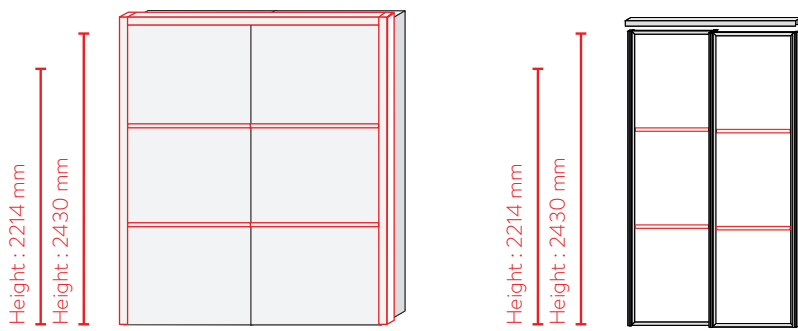

ORDERING INFORMATION SLIDING DOORS

a PLANNING

- Our sliding door system meets flexible wardrobe and room planning options.
- To keep planning of the doors simple and flexible, every order is based on a set. This includes set number, track profile colour, front décor as well as dimensions of the entire wardrobe or room planning.

b FITTINGS

- All sets consist of a track side and sliding doors incl. top track position holders, sealing brush and bottom track stopper. This covers the relevant accessories even for complex room solutions.

c ORDER

- When placing your order, please indicate the total width and height of the sliding doors system in addition to the set number. The tracks are supplied precisely with the specified width dimension without a size allowance.

d DELIVERY

- The sliding door range is part of the furniture gross charging group. It can be combined with all furniture components from the standard range and invoiced. The delivery is made together with the overall consignment.

SITUATION-SPECIFIC ACCESSORIES

Accessories which depend on the specific installation situation must be ordered in addition:

- Sliding door brakes, invoiced per item.
- Tilt protection (is automatically invoiced for sliding doors under 750 mm with a sliding door brake)
- Wall connection, invoiced per started 100 mm.
- Cover caps for top and bottom tracks incl. top track stopper
- Ceiling track end caps and ceiling track centre support

SLIDING DOOR SETS *

As a rule, all sets consist of the following components:

1. Track set, consisting of bottom and top tracks and top track supports if required:
The calculation is made per started 100 mm and the number of top track supports if required
Please state the profile colour when ordering: 014 Stainless steel appearance or 010 Black.
2. Sliding door(s) incl. top track position holder, sealing brush and bottom track stopper:
The price of a sliding door is calculated from a fixed base price per sliding door GGT (1404) plus a price per m² GT120 (1401).
3. For planning with a passe-partout frame on the carcass, the passe-partout frame (PR25) must be ordered in addition.



Surcharges, sliding door brakes, tilt protection, passe-partout frame, cover caps for bottom and tracks are not included in the set, but must be ordered in addition based on the installation situation.

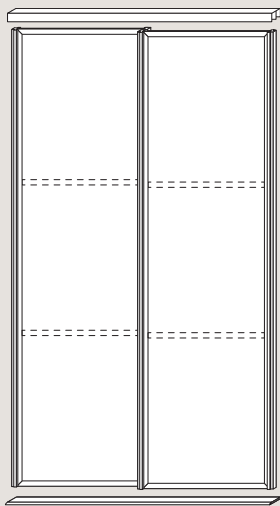

Set 2: GSSET-002 (1442)

Double-track sliding doors system with 2 doors

consisting of:

- | | |
|--------------|---|
| 2 x GGT | Base price for sliding doors |
| 2 x GT120 | 2 sliding doors incl. top track position holder, sealing brush and bottom track stopper |
| 1 x GSSET-2L | double-track track set |

For door widths from 500 to 1200 mm.

We recommend 2 sliding door brakes for doors upwards of 750 mm in width.

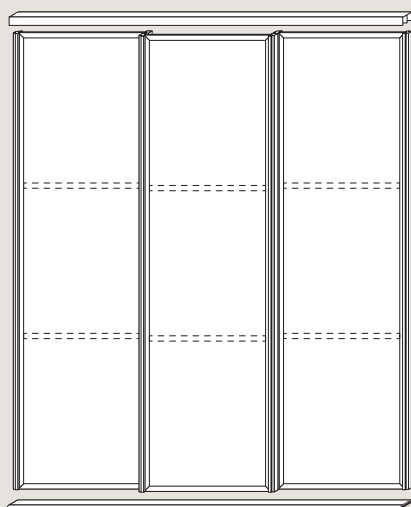
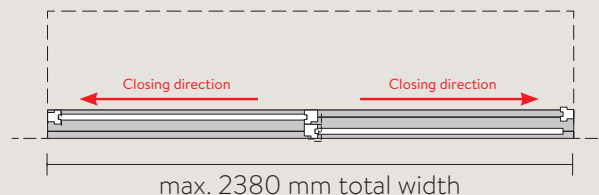

Set 3: GSSET-003 (1443)

Double-track sliding doors system with 3 doors

consisting of:

- | | |
|--------------|---|
| 3 x GGT | Base price for sliding doors |
| 3 x GT120 | 3 sliding doors incl. top track position holder, sealing brush and bottom track stopper |
| 1 x GSSET-2L | double-track track set |

For door widths from 500 to 1200 mm.

We recommend min. 1 sliding door brake per door for doors upwards of 750 mm in width.

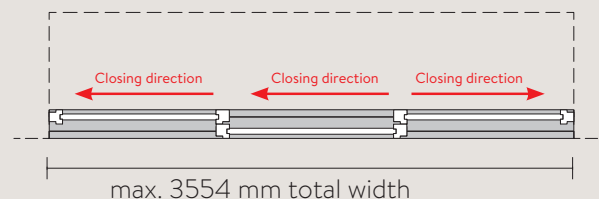

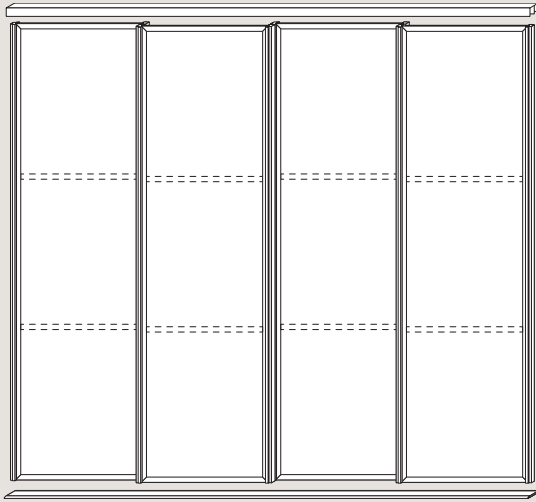

Set 4: GSSET-004 (1444)

Double-track sliding doors system with 4 doors

consisting of:

- 4 x GGT Base price for sliding doors
- 4 x GT120 4 sliding doors incl. top track position holder, sealing brush and bottom track stopper
- 1 x GSSET-2L double-track track set

For door widths from 500 to 1200 mm.

We recommend min. 1 sliding door brake per door for doors upwards of 750 mm in width.

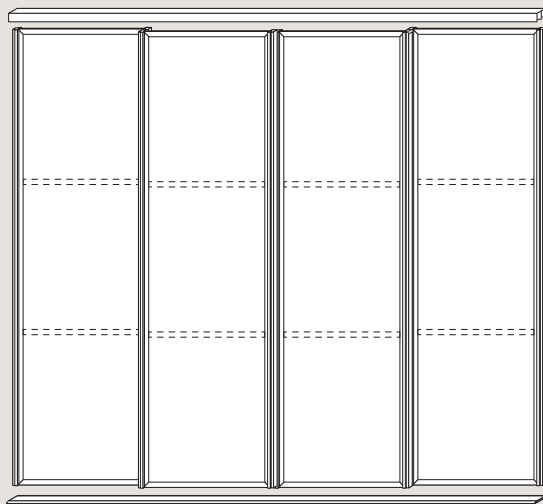
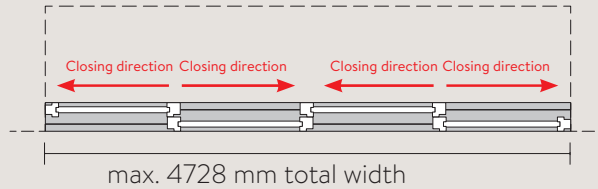

Set 5: GSSET-005 (1445)

Double-track sliding doors system with 4 doors

consisting of:

- 4 x GGT Base price for sliding doors
- 4 x GT120 4 sliding doors incl. top track position holder, sealing brush and bottom track stopper
- 1 x GSSET-2L double-track track set

For door widths from 500 to 1200 mm.

We recommend min. 1 sliding door brake per door for doors upwards of 750 mm in width.

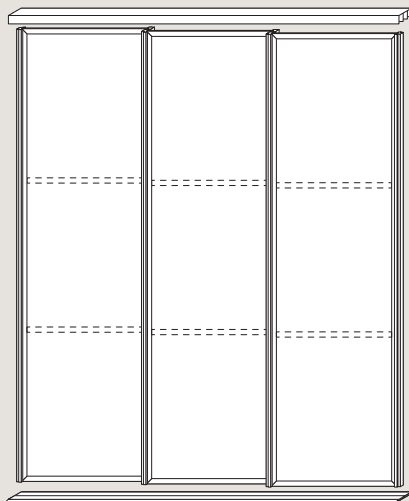
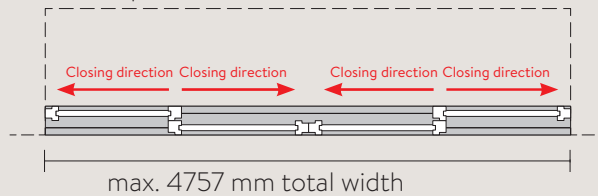

Set 6: GSSET-006 (1446)

Triple-track sliding doors system with 3 doors

consisting of:

- 3 x GGT Base price for sliding doors
- 3 x GT120 3 sliding doors incl. top track position holder, sealing brush and bottom track stopper
- 1 x GSSET-3L triple-track track set

For door widths from 500 to 1200 mm.

We recommend min. 1 sliding door brake per door for doors upwards of 750 mm in width.

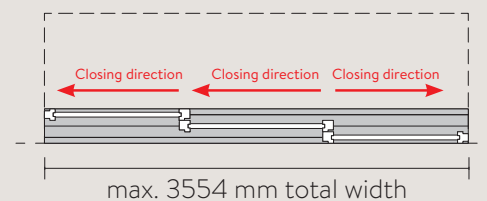

SLIDING DOORS

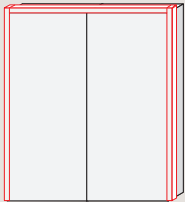
Item description	Order no.	Width in mm	Abbreviation	Points
 <p>Passepartout frame to frame wardrobes, and as frame for sliding door installation</p> <p>Please indicate the unit width in the order. For wardrobe unit widths of over 2518 mm, the cover shelf is supplied in two or more parts of identical size.</p>	25005	–	PR25-220	729
	25015	–	PR25-240	734

Item description	Order no.	Abbreviation	Width in mm	Price groups / Points
<p>Base price for sliding doors (One base price will be invoiced per sliding door.)</p>	1404	GGT	–	1.317

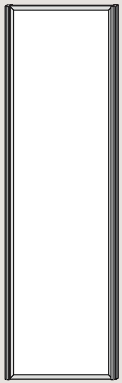
Item description	Order no.	Abbreviation	Width in mm	Price groups / Points			
				2	3	4	7
 <p>Sliding door Aluminium frame, panel coated on both sides, incl. top track position holder, sealing brush and bottom track stopper in black or grey</p> <p>Width: 500 to 1200 mm Height: 700 to 2600* mm</p> <p>Wood and concrete décors only up to a height of 2000 mm</p> <p>Permissible fronts: 336, 338, 341, 402*, 405*, 488, 491, 889*, 892*, 961, 967, 969, 970, 101 mirror, 103 mirror, bronze colour, 104 grey glass ESG * only up to 2000 mm height</p>	1401	GT	500 – 1200	88	276	296	404
				<p>(The price is invoiced per m² plus the base price per sliding door GGT (1404). Minimum door dimensions W x H: 500 x 700 mm. Only available together with a sliding door set. Cannot be ordered as a separate item.)</p>			

 <p>Surcharge for sliding door with panel-dividing rail the height of the panel is symmetrically divided into thirds</p>	1406	GTS	500 – 1200	415	415	415	415
				<p>(Invoiced per door. Please indicate which door is to be divided when placing your order.)</p>			

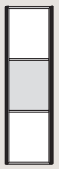
 <p>Surcharge for different décor on sliding doors with panel-dividing rails The centre panel is available in a different décor.</p>	1407	MP-GTDW		127	127	127	127
				<p>(Invoiced per door. Please specify the décor number in your order.)</p>			

Item description	Order no.	Depth in mm	Abbreviation	Points
 <p>Track set for sliding doors consisting of: bottom and top tracks Bottom track height: 6.4 mm Top track height: 40 mm</p> <p>Available in: 014 Stainless steel appearance, 010 Black</p> <p>Price per 100 mm, every 100 mm started will be invoiced.</p>	1432	79	GSSET-2L	13,1
	1433	117	GSSET-3L	20,1

ACCESSORIES FOR SLIDING DOORS

	Item description	Order no.	Abbreviation	Points
	<p>Covering cap set for bottom and top tracks for sliding doors without a stop placed laterally to the wall, consisting of: 1 covering cap for the bottom track, 1 covering cap for the top track incl. top track stopper</p> <p>Available in: 014 Stainless steel appearance 010 Black</p>	1438 1439	GSEK-2L GSEK-3L	175 225
	<p>Ceiling track end caps to be mounted in front of wall</p> <p>Available in: 014 Stainless steel appearance 010 Black</p>	1408	GSWSTE	130
	<p>Ceiling track centre support to be mounted in front of wall</p> <p>Available in: 014 Stainless steel appearance, 010 Black</p> <p>One ceiling track centre support per full 750 mm is calculated for GSWSET-001/002. One ceiling track centre support is calculated per 750 mm or part thereof for GSWSET-003.</p>	1409	GSWSTM	31
	<p>Wall connection for a clean finish even with uneven walls, adjustment range ± 5 mm</p> <p>Available in: 014 Stainless steel appearance, 010 Black</p> <p>Price per 100 mm, every 100 mm started will be invoiced. The wall connection decreases the available opening width by 25 mm.</p>	1440	GTWA	14,3
	<p>Sliding door brake with integrated gas pressure spring with integrated damper and closing mechanism</p> <p>Invoiced per sliding door brake. Please indicate the number of sliding door brakes per door. For door widths of 750 mm or more, we recommend min. 1 sliding door brake.</p>	1435	GTBR	175
	<p>Tilt protection for sliding doors with a sliding door brake and a width of less than 750 mm</p> <p>Invoiced per door. A tilt protection is obligatory for sliding doors with a sliding door brake and a width of less than 750 mm.</p>	1436	GTKIPPS	22

OCCASIONAL FURNITURE AND ACCESSORIES STAND-ALONE PIECES



CHEST OF DRAWERS | H 756 mm | D 485 mm

Dimensions and delivery including top shelf

	Item description	Order no.	Abbreviation	Width in mm	Price groups / Points		
					2	3	4
	Chest of drawers 1 door 1 insertable shelf						
	Door hinged on the left	130018	KOT40-76L	403	507	541	571
	Door hinged on the right	130019	KOT40-76R	403	507	541	571
	Optional accessories 1 x surcharge carcass interior décor	7947	MP-KID		+ 96	+ 96	+ 96
	Chest of drawers 2 doors 1 insertable shelf	130020	KO2T80-76	803	893	953	1036
		130021	KO2T120-76	1,203	1,129	1,208	1,344
	Optional accessories 2 x surcharge carcass interior décor	7947	MP-KID		+ 193	+ 193	+ 193
	Chest of drawers 1 drawer 2 pull-outs	130022	KOS2A40-76	403	1,346	1,375	1,400
		130023	KOS2A80-76	803	1,829	1,872	1,975
		130024	KOS2A120-76	1,203	2,221	2,287	2,453
	Optional accessories 1 x surcharge carcass interior décor	7947	MP-KID		+ 96	+ 96	+ 96
	Chest of drawers 1 door 1 insertable shelf 1 drawer 2 pull-outs	130025	KOTS2A120-76L	1,203	2,336	2,413	2,546
	Mirrored version	130026	KOTS2A120-76R	1,203	2,336	2,413	2,546
	Optional accessories 2 x surcharge carcass interior décor	7947	MP-KID		+ 193	+ 193	+ 193

CHEST OF DRAWERS | H 756 mm | D 485 mm

Dimensions and delivery including top shelf

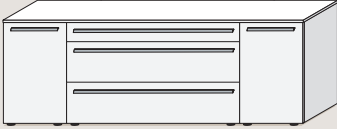
	Item description	Order no.	Abbreviation	Width in mm	Price groups / Points		
					2	3	4
	Chest of drawers 1 door 1 insertable shelf 1 drawer 2 pull-outs	130027	KO-S2AS120-76L	1,203	2,109	2,179	2,312
	Mirrored version	130028	KOTS2AS120-76R	1,203	2,109	2,179	2,312
	Optional accessories 2 x surcharge carcass interior décor	7947	MP-KID		+ 193	+ 193	+ 193
	Chest of drawers 2 doors 2 insertable shelves 1 drawer 2 pull-outs	130029 130030	KO2TS2A160-76 KO2TS2A200-76	1,603 2,003	2,843 3,235	2,954 3,368	3,117 3,596
	Optional accessories 3 x surcharge carcass interior décor	7947	MP-KID		+ 289	+ 289	+ 289

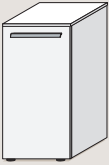
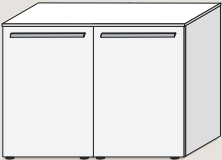

CHEST OF DRAWERS | H 900 mm | D 485 mm

Dimensions and delivery including top shelf

	Item description	Order no.	Abbreviation	Width in mm	Price groups / Points		
					2	3	4
	Chest of drawers 1 door 2 insertable shelves						
	Door hinged on the left	130031	KOT40-90L	403	560	601	642
	Door hinged on the right	130032	KOT40-90R	403	560	601	642
	Optional accessories 1 x surcharge carcass interior décor	7947	MP-KID		+ 96	+ 96	+ 96
	Chest of drawers 2 doors 2 insertable shelves	130033 130034	KO2T80-90 KO2T120-90	803 1,203	984 1,248	1,051 1,338	1,155 1,494
	Optional accessories 2 x surcharge carcass interior décor	7947	MP-KID		+ 193	+ 193	+ 193



CHEST OF DRAWERS | H 900 mm | D 485 mm

Dimensions and delivery including top shelf

	Item description	Order no.	Abbreviation	Width in mm	Price groups / Points		
					2	3	4
	Chest of drawers 3 pull-outs	130035	KO3A40-90	403	1,430	1,461	1,506
		130036	KO3A80-90	803	1,991	2,058	2,177
		130037	KO3A120-90	1,203	2,396	2,494	2,681
	Optional accessories 1 x surcharge carcass interior décor	7947	MP-KID		+ 96	+ 96	+ 96
	Chest of drawers 2 drawers 2 pull-outs	130038	KO2S2A40-90	403	1,678	1,706	1,744
		130039	KO2S2A80-90	803	2,238	2,286	2,403
		130040	KO2S2A120-90	1,203	2,647	2,695	2,892
	Optional accessories 1 x surcharge carcass interior décor	7947	MP-KID		+ 96	+ 96	+ 96
	Chest of drawers 1 door 1 insertable shelf 2 drawers 2 pull-outs	130041	KOT2S2A120-90L	1,203	2,798	2,887	3,045
		Mirrored version	130042	KOT2S2A120-90R	1,203	2,798	2,887
	Optional accessories 2 x surcharge carcass interior décor	7947	MP-KID		+ 193	+ 193	+ 193

CHEST OF DRAWERS | H 900 mm | D 485 mm

Dimensions and delivery including top shelf

	Item description	Order no.	Abbreviation	Width in mm	Price groups / Points		
					2	3	4
	Chest of drawers 1 door 1 insertable shelf 3 pull-outs	130043	KOT3A120-90L	1,203	2,271	2,358	2,511
	Mirrored version	130044	KOT3A120-90R	1,203	2,271	2,358	2,511
	Optional accessories 2 x surcharge carcass interior décor	7947	MP-KID		+ 193	+ 193	+ 193
	Chest of drawers 2 doors 2 insertable shelves 2 drawers 2 pull-outs	130045	KO2T2S2A160-90	1,603	3,358	3,488	3,686
		130046	KO2T2S2A200-90	2,003	3,766	3,896	4,175
	Optional accessories 3 x surcharge carcass interior décor	7947	MP-KID		+ 289	+ 289	+ 289

BEDSIDE TABLES FLOOR-STANDING | H 468 mm | D 374 mm

Dimensions and delivery including top shelf

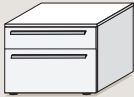
	Item description	Order no.	Abbreviation	Width in mm	Price groups / Points		
					2	3	4
	Bedside tables	130001	NASA40-47	403	1,063	1,081	1,095
	1 drawer	130002	NASA60-47	603	1,212	1,235	1,250
	1 pull-out						
	Optional accessories						
	1 x surcharge carcass interior décor	7947	MP-KID		+ 96	+ 96	+ 96

BEDSIDE TABLES FLOOR-STANDING | H 612 mm | D 374 mm

Dimensions and delivery including top shelf

	Item description	Order no.	Abbreviation	Width in mm	Price groups / Points		
					2	3	4
	Bedside tables	130003	NA2A40-61	403	1,168	1,181	1,216
	2 pull-outs	130004	NA2A60-61	603	1,279	1,306	1,357
	Optional accessories						
	1 x surcharge carcass interior décor	7947	MP-KID		+ 96	+ 96	+ 96
	Bedside tables	130005	NA2SA40-61	403	1,410	1,432	1,455
	2 drawers	130006	NA2SA60-61	603	1,537	1,553	1,604
	1 pull-out						
	Optional accessories						
	1 x surcharge carcass interior décor	7947	MP-KID		+ 96	+ 96	+ 96

BEDSIDE TABLES WALL-MOUNTED | H 304 mm | D 374 mm

Dimensions and delivery including top shelf

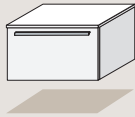
	Item description	Order no.	Abbreviation	Width in mm	Price groups / Points		
					2	3	4
	Bedside table wall-mounted	130007	NAA40-30H	403	706	716	719
	1 pull-out	130008	NAA60-30H	603	826	843	855
	Optional accessories 1 x surcharge carcasse interior décor	7947	MP-KID		+ 96	+ 96	+ 96

BEDSIDE TABLES WALL-MOUNTED | H 376 mm | D 374 mm

Dimensions and delivery including top shelf

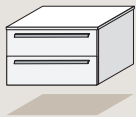
	Item description	Order no.	Abbreviation	Width in mm	Price groups / Points		
					2	3	4
	Bedside table wall-mounted	130009	NAA40-38H	403	713	719	734
	1 pull-out	130010	NAA60-38H	603	842	859	874
	Optional accessories 1 x surcharge carcasse interior décor	7947	MP-KID		+ 96	+ 96	+ 96
	Bedside table wall-mounted	130011	NA2S60-38H	603	1,079	1,097	1,108
	2 drawers						
	Optional accessories 1 x surcharge carcasse interior décor	7947	MP-KID		+ 96	+ 96	+ 96

BEDSIDE TABLES WALL-MOUNTED | H 488 mm | D 374 mm

Dimensions and delivery including top shelf

	Item description	Order no.	Abbreviation	Width in mm	Price groups / Points		
					2	3	4
	Bedside table wall-mounted	130012	NASA40-45H	403	1,003	1,021	1,033
	1 drawer 1 pull-out	130013	NASA60-45H	603	1,151	1,168	1,187
	Optional accessories 1 x surcharge carcass interior décor	7947	MP-KID		+ 96	+ 96	+ 96

BEDSIDE TABLES WALL-MOUNTED | H 592 mm | D 374 mm



Dimensions and delivery including top shelf

	Item description	Order no.	Abbreviation	Width in mm	Price groups / Points		
					2	3	4
	Bedside table wall-mounted	130014	NA2A40-59H	403	1,126	1,139	1,176
	2 pull-outs	130015	NA2A60-59H	603	1,218	1,244	1,294
	Optional accessories 1 x surcharge carcass interior décor	7947	MP-KID		+ 96	+ 96	+ 96
	Bedside table wall-mounted	130016	NA2SA40-59H	403	1,412	1,428	1,452
	2 drawers 1 pull-out	130017	NA2SA60-59H	603	1,522	1,536	1,591
	Optional accessories 1 x surcharge carcass interior décor	7947	MP-KID		+ 96	+ 96	+ 96

ACCESSORIES

INTERNAL DRAWERS AND PULL-OUTS NBOX

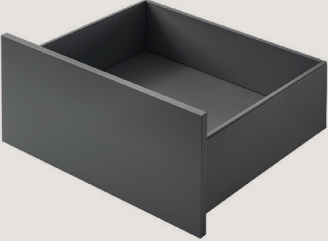

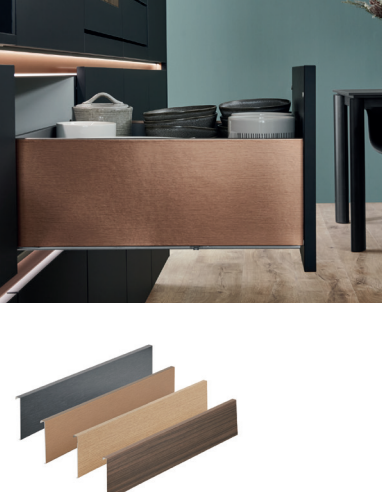
	Item description	Order no.	Abbreviation	Points
	<p>Surcharge for pull-out box Closed side frame, 10.7 mm thick, usable as pull-out.</p> <p>A surcharge is invoiced per pull-out.</p>	7905	MP-BOX	98
	<p>Surcharge for glass side Glass insert (8 mm TSG), usable on all pull-outs with rectangular railing.</p> <p>Available in: G001 Grey glass G058 Parsol glass, bronze</p> <p>A surcharge is invoiced per pull-out.</p>	7915	MP-GLAS	127
	<p>Surcharge for design profile Individually selectable frame end, plastic profile for clipping on, usable on all drawers and pull-outs.</p> <p>A surcharge is invoiced per drawer and pull-out.</p> <p>Available in: P194 Slate grey P198 Sierra oak reproduction P199 Anthracite metallic colour P211 Bronze metallic colour P399 Milano walnut reproduction</p> <p>Not possible for pull-outs with glass side (MP-GLAS) and low frame (MP-NIEZA).</p>	7918	MP-DPRO	23
	<p>Surcharge for design cover Individually selectable design for frame side, aluminium profile for clipping on, usable on all drawers and pull-outs.</p> <p>A surcharge is invoiced per drawer and pull-out.</p> <p>Available in: C198 Sierra oak reproduction C199 Anthracite metallic color C211 Bronze metallic colour C399 Milano walnut reproduction</p> <p>Not possible for pull-outs with glass side (MP-GLAS) and low frame (MP-NIEZA).</p>	7923	MP-DCOV	55

	Item description	Order no.	Abbreviation	Points
	<p>Surcharge for mechanical opening support mechanism on nBOX drawers and pull-outs without handle drilling and handle, factory-installed</p> <p>A surcharge is invoiced per drawer or pull-out.</p> <p>Not possible on furniture marked accordingly. Cannot be retrofitted or supplied separately!</p>	7692	MP-PTOSA	158

CARCASE INTERIOR DÉCOR

	Item description	Order no.	Abbreviation	Points
	<p>Surcharge for carcass interior décor in Slate grey for units with interior and exterior décor in no. 194 Slate grey</p> <p>Available carcass colours: 194 Slate grey The interior décor can only be selected with the carcass décor 194 Slate grey (exterior).</p> <p>A surcharge is invoiced per unit.</p>	7947	MP-KID	96

WALL SHELF INSERT | H 16 mm

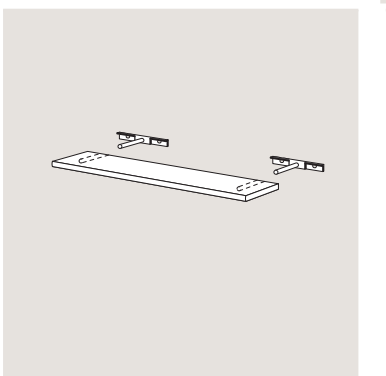
	Item description	Order no.	Abbreviation	Width in cm	Points
	<p>Plug-in wall-mounted shelf 16 mm thick carcass material, polymer edging all around, 150 mm deep, incl. metal plug fitting, 6 kg load per pair of supports</p> <p>Dimensional changes can only be made on site! Width reductions only possible up to 25 mm on each side!</p> <p>Upwards of 800 mm widths will be supplied with 3 plug-in fittings.</p>	16011 16015 16018 16020 16022	WB1640 WB1660 WB1680 WB16100 WB16120	40 60 80 100 120	274 279 439 445 448

MIRRORS

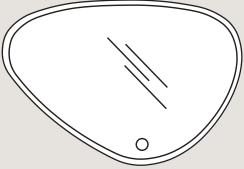
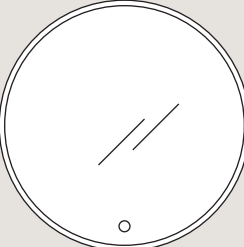
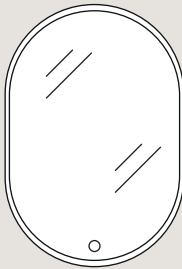
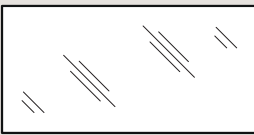
Item description	Order no.	Abbreviation	Width in cm	Points
	<p>Mirror GRAYCE with LED lights Width: 900/1200, height: 600/800 mm 1 all around sandblasted LED light window, 10 mm wide, depth: 24 mm, LED - 24 V DC, 3000 - 6000 K, degree of protection IP 44, 1 touch sensor, 1 connecting cable/220 - 240 V</p> <p>Energy efficiency rating E</p> <p>Horizontal and vertical assembly possible.</p>	<p>15213 SP-GRAYCE90B 15215 SP-GRAYCE120B</p>	<p>90 120</p>	<p>991 1,127</p>
	<p>Mirror ABRIL with LED lighting all round Diameter 600 mm, 42 mm deep, 1 plastic frame silver, 1 plastic profile all round with LED lighting, LED - 12 V DC, 3000 - 6500 K, protection class IP 44, 1 touch dimmer, 1 connection cable / 220 - 240 V</p> <p>Energy efficiency class F</p>	<p>15297 SP-ABRILB60</p>	<p>60</p>	<p>692</p>
	<p>Mirror ABRIL oval with LED lighting all round 1000 mm high, 43 mm deep, 1 plastic frame silver, 1 plastic profile all round with LED lighting, LED - 12 V DC, 3000 - 6500 K, protection class IP 44, 1 touch dimmer, 1 connection cable / 220 - 240 V</p> <p>Energy efficiency class E</p> <p>Horizontal and vertical assembly possible.</p>	<p>15217 SP-ABRILOB50</p>	<p>50</p>	<p>1,013</p>
	<p>Mirror with side bevel 576 mm high, 40 mm deep, on backing material, all around with polymer edge in carcase colour, with side bevel. As optional lighting we recommend the LED attachment light LAPSP and/or the LED ambient lighting Hide LSIDHW-58. The LED starter set can be stored behind the mirror.</p>	<p>15961 SPL-FACB80-58 15964 SPL-FACB120-58 15966 SPL-FACB160-58</p>	<p>80 120 160</p>	<p>470 580 670</p>
<p>as above, but in portrait format</p>		<p>15284 SPLG-FACB40-158 15286 SPLG-FACB60-158 15288 SPLG-FACB80-158</p>	<p>40 60 80</p>	<p>593 692 851</p>

Notes / sketches

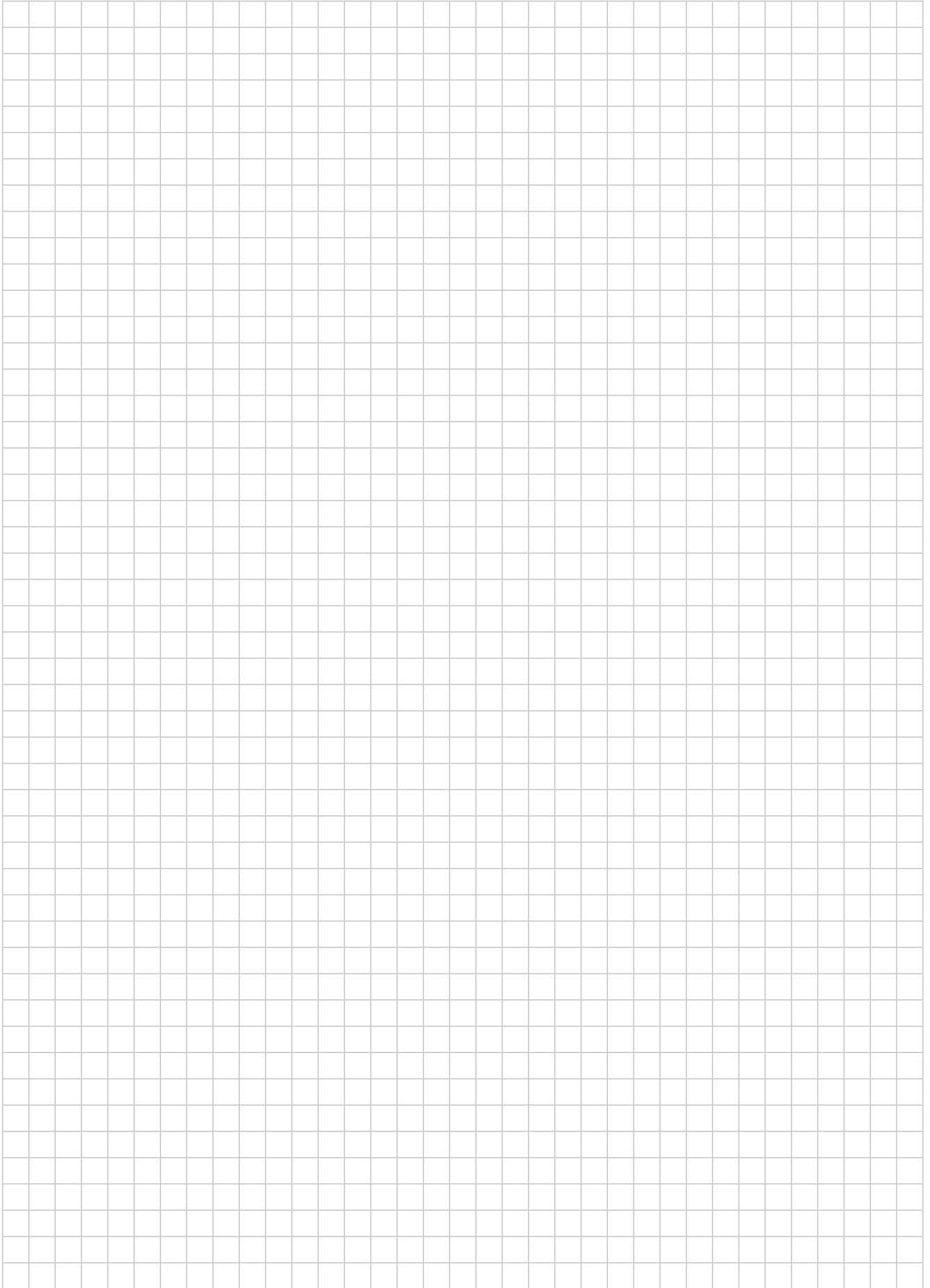

CONSISTENT LIVING CONCEPT

We develop coordinated furnishing solutions for the entire home. Kitchen, bathroom, living and now also the bedroom can be designed with the same style and combined harmoniously. In addition to this, we provide solutions for utility rooms, cloakrooms and home office areas, which seamlessly integrate into the overall concept. Our approach: See rooms as a whole and design them so that the interior furnishings result in a coordinated room concept.



KITCHEN

With decades of experience and extensive know-how in the kitchen segment, we offer solutions that meet the highest demands on planning, design and quality. Our kitchens are characterised by versatile and individual design options – from tailored concepts and a large selection of surface and décors up to flexible planning options. A precise finish, durable materials and a high degree of comfort and functionality ensure that our kitchens not only impress visually, but also reliably endure daily use.

BATHROOM

We also apply this coordinated design to the bathroom. High-quality wash basins, matching mirrors and storage space solutions are combined with selected surfaces and décors and finished precisely. This results in a balanced overall picture, combining comfort and functionality. For well thought out, precise and uncomplicated solutions.

BEDROOM

Following kitchen, bathroom and living, the bedroom can now also be integrated into the coordinated furnishing concept. Our wardrobe systems open up plannable solutions, adapted precisely to the available space and requirement. Whether it is classic hinged doors or modern sliding doors. A coordinated look is created with matching chests of drawers and bedside tables, continuing the style of the entire home. This makes the bedroom part of a harmonised overall concept providing maximum well-being.

LIVING

Living spaces subsist on ambience. Our furniture for this area combines timeless design with homely touches. Whether this is generous tables with a lot of space for social get-togethers, comfortable chairs or open shelves. The result are rooms that equally support every day use and special moments. Suitable cloakroom solutions and home office furniture pick up the style and seamlessly continue this into the defined living spaces.

UTILITY ROOM

Organising made easy: From storage to work areas, the utility room is optimally utilised with clever planning. Supplies, cleaning utensils or washing agents can be stored here in a structured way. Our well thought out organisation aids and combinable modules create additional space, simplify processes and flexibly adapt to your requirements. Functional details and a clear design ensure that every centimetre is optimally used.



Schlafzimmer Dream - EN

92561



neutral